

JUPITER-Z2505T

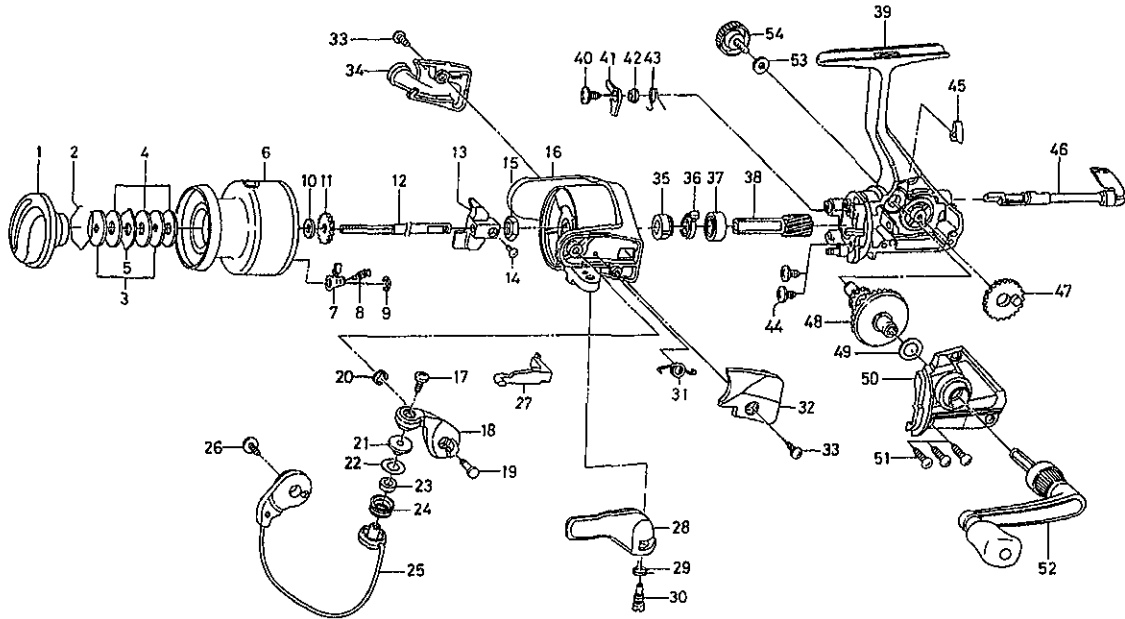

Key No.	Parts No.	Parts Name
2-9	F61-0101	SPOOL
1	F32-2105	DRAG KNOB
2	171-7701	DRAG WASHER RET
3	E46-7201	KEY WASHER
4	E13-6003	DRAG WASHER
5	373-3603	EARED WASHER
7	B07-5304	CLICK PAWL
8	E40-3101	CLICK SPRING
9	320-5901	CLICK RET
10	E46-7101	SPOOL WASHER
11	270-6501	CLICK GEAR
12	F61-9401	MAIN SHAFT
13	F39-5801	OSC SLIDER
14	351-0315	OSC SLIDER SCREW
15	341-9201	ROTOR NUT
16	F31-0114	ROTOR
17	B67-9304	LINE ROLLER SCREW
18	F61-9301	BAIL ARM
19	E49-3501	BAIL ARM SCREW
20	320-5901	BAIL ARM SCREW RET
21	F44-6302	LINE ROLLER COLLAR
22	F44-6202	LINE ROLLER WASHER
23	F47-3401	LINE ROLLER BUSHING
24	F45-4901	LINE ROLLER
25	F61-9701	BAIL
26	B84-2102	BAIL HOLDER SCREW
27	E45-1601	BAIL TRIP LEVER

Key No.	Parts No.	Parts Name
28	F18-0010	TRIGGER LEVER
29	E36-9901	TRIGGER SPRING
30	E37-0003	TRIGGER SCREW
31	F12-8901	BAIL SPRING
32	F31-0509	BAIL SPRING COVER
33	E36-4202	BAIL SPRING COVER SCREW
34	F31-0809	BAIL TRIP COVER
35	E38-5501	SPRING HOLDER
36	E49-2401	A/R RATCHET
37	L03-6601	BALL BEARING
38	L01-3902	PINION GEAR
39	F60-9802	BODY
40	L00-1801	A/R PAWL SCREW
41	L01-4401	A/R PAWL
42	L01-4302	A/R PAWL COLLAR
43	L00-1501	A/R PAWL SPRING
44	E03-7801	BEARING RET SCREW
45	F36-5901	A/R CAM SPRING
46	F08-5121	A/R LEVER
47	F60-6001	OSC GEAR
48	F08-4801	DRIVE GEAR
49	373-7808	DRIVE GEAR WASHER
50	F80-9902	SIDE COVER
51	B83-5002	SIDE COVER SCREW
52	F61-2401	HANDLE
53	B92-4902	HANDLE LOCK WASHER
54	F03-5605	HANDLE LOCK SCREW