

# JUPITER-Z1505T

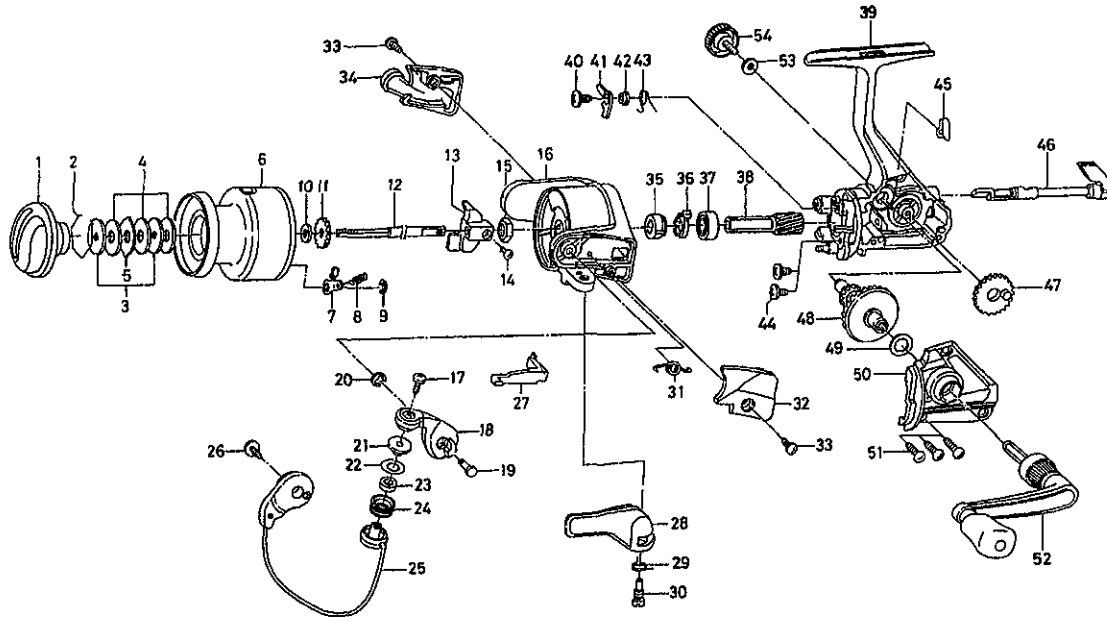

Key No.	Parts No.	Parts Name	Key No.	Parts No.	Parts Name
2-9	F81-4101	SPOOL	28	E49-3410	TRIGGER LEVER
1	F32-8504	DRAG KNOB	29	E36-9901	TRIGGER SPRING
2	F37-3301	DRAG WASHER RET	30	E37-0002	TRIGGER SCREW
3	E46-7201	KEY WASHER	31	E49-6801	BAIL SPRING
4	E13-6001	DRAG WASHER	32	F32-4104	BAIL SPRING COVER
5	373-3603	EARED WASHER	33	E24-8101	BAIL SPRING COVER SCREW
7	B07-5304	CLICK PAWL	34	F32-6504	BAIL TRIP COVER
8	E40-3101	CLICK SPRING	35	F12-2101	SPRING HOLDER
9	320-5901	CLICK RET	36	E49-8501	A/R RATCHET
10	E46-7101	SPOOL WASHER	37	634-1301	BALL BEARING
11	270-6501	CLICK GEAR	38	F12-1601	PINION GEAR
12	F46-0801	MAIN SHAFT	39	F61-3702	BODY
13	F12-2301	OSC SLIDER	40	F12-5701	A/R PAWL SCREW
14	351-0311	OSC SLIDER SCREW	41	F12-1901	A/R PAWL
15	341-9201	ROTOR NUT	42	F12-3501	A/R PAWL COLLAR
16	F32-1409	ROTOR	43	F12-3401	A/R PAWL SPRING
17	B67-9308	LINE ROLLER SCREW	44	E03-7801	BEARING RET SCREW
18	F47-3801	BAIL ARM	45	F12-2001	A/R CAM SPRING
19	E49-3501	BAIL ARM SCREW	46	F08-5128	A/R LEVER
20	320-5901	BAIL ARM SCREW RET	47	F12-2201	OSC GEAR
21	F44-6302	LINE ROLLER COLLAR	48	F12-1501	DRIVE GEAR
22	F44-6202	LINE ROLLER WASHER	49	375-8502	DRIVE GEAR WASHER
23	F47-3401	LINE ROLLER BUSHING	50	F61-3802	SIDE COVER
24	F45-4901	LINE ROLLER	51	E15-8602	SIDE COVER SCREW
25	F62-0201	BAIL	52	E49-7402	HANDLE
26	B84-2102	BAIL HOLDER SCREW	53	F02-0202	HANDLE LOCK WASHER
27	E49-6401	BAIL TRIP LEVER	54	F67-6502	HANDLE LOCK SCREW